

**SCHRÖDER**  
GROUP



FOLDING MACHINE  
**MAK 4 Evolution UD**

# MAK 4 Evolution UD

The MAK 4 Evolution UD is our solution for complex tasks involving industrial sheet metal working – powerful, precise, and extremely efficient.



The MAK 4 Evolution UD combines the Schröder groups' many years of experience in sheet metal folding with pioneering innovations: precise linear drive, graphical programming, and an automatic tool changer.

With the MAK 4 Evolution UD you are able to work more productively thanks to the „up-and-down“ technology. All of this opens up new opportunities to your company for processing sheet metal – for faster, more flexible production and reduced costs per unit.

The MAK 4 Evolution UD enables you to turn your customer's increasing demands in quality, flexibility, and speed into competitive advantages for your company. No matter whether complex sheet metal forming needs to be particularly precise, short-notice individual orders need to be managed reliably, or pieces of sheet metal need to be processed quickly and efficiently for standard products, the MAK 4 Evolution UD makes it all possible.

**Up-and-down technology reduces processing times**

Minimize handling costs at the machine and trust Schröder's proven "up-and-down" technology. More processing steps in shorter times.

Standard equipment	
Software control	<ul style="list-style-type: none"> <li>- POS 3000 3-D Graphic control on swivelling arm</li> <li>- Radius function</li> <li>- Remote maintenance via internet</li> </ul>
Clamping beam	<ul style="list-style-type: none"> <li>- Stroke: 1090 mm</li> <li>- Geometry: 180°</li> <li>- Hydraulic tool clamping device (WZS 5000)</li> </ul>
Folding beam	<ul style="list-style-type: none"> <li>- Up'n Down folding beam, automatically controlled</li> <li>- Pneumatic tool clamping device (WZS 7000)</li> <li>- Motorized folding beam adjustment: 180 mm</li> <li>- Motorized folding center adjustment: 100 mm</li> <li>- Central crowning device, motorized</li> <li>- Center point adjustment, converter-controlled drive</li> </ul>
Back gauge system	<ul style="list-style-type: none"> <li>- Gauge table 1700 mm as U-shape, segmented support plates with steel balls</li> <li>- Lateral angle gauge right and left side 1500 mm (outside)</li> <li>- Suction plates in gauge table, controlled via POS 3000</li> <li>- 2 pneumatic pop-up square arms assembled aisle side, program-controlled</li> <li>- Gauge axis in front</li> </ul>
Work safety	<ul style="list-style-type: none"> <li>- Protection via light barrier controlled by safety-PLC for operation from the rear</li> <li>- Safety package for operation from the front incl. 2nd foot switch on rail for lateral movement (in combination with tool changer clamping beam no operation from the front possible)</li> </ul>
Others	<ul style="list-style-type: none"> <li>- Standard machine without tools</li> <li>- Foot switch</li> <li>- Anchor plates incl. dowels</li> </ul>

Special equipment	
Clamping beam	<ul style="list-style-type: none"> <li>- Fully automatic tool changer (WSZ 6000) with a hydraulic tool clamping device (a total of 8 axis) for max. tool height of 500 mm (without toolings), two asynchronously movable tool changers with one gripper unit each <ul style="list-style-type: none"> <li>▪ incl. safety fence with lateral access door</li> <li>▪ incl. air conditioner on both switch cabinets</li> <li>▪ Central lubrication, program-controlled via POS 3000</li> </ul> </li> </ul>
Folding beam	<ul style="list-style-type: none"> <li>- Additional option, automatic tool changer for folding beam tools with pneumatic tool clamping device WZS 7100 incl. one folding beam tool set</li> </ul>
Back gauge system	<ul style="list-style-type: none"> <li>- Side table left or right, sheet support table closed with ball rollers (see graphic p.10)</li> <li>- Pneumatically lowerable gauge fingers (2 sectors 850/1700 mm)</li> <li>- Back gauge extension right and/or left with pneumatically lowerable gauge fingers (balls in table), combinable with side table</li> </ul>
Work safety	<ul style="list-style-type: none"> <li>- Additional equipment for 2-man-operation control in accordance with accident prevention rules required</li> </ul>
Software control	<ul style="list-style-type: none"> <li>- External programming (PC-Version) 1 licence</li> <li>- Schröder Unfold software (POS 3000 PC Version required)</li> </ul>
Others	<ul style="list-style-type: none"> <li>- Tool cart for blades, rails and segmented tools</li> <li>- Voltage transformer 52 kVA</li> <li>- Air conditioner on both switch cabinets</li> <li>- Tools, please see p. 6-7</li> <li>- Information on software control, please see p. S. 8-9</li> </ul>

# Fully automatic tool changer

Precise and extremely fast: The fully automatic tool changer allows you to reduce preparation times for small series effectively, reduces equipping errors, and increases output at the same time.



Two rotating units with one gripper arm each remove the tools from the magazine.



Drives, tools, stops - quality can be seen in every detail.

## Equip quickly and safely

The MAK 4 Evolution UD may be equipped with a fully automatic tool changer. In just a few seconds, the clamping beam (and optionally the folding beam) can be equipped with tools. Two rotating units operated via highly precise linear drives remove the tools from the magazine using one gripper arm each and then position them in the tool clamping device or disassemble the current tools.

All information about products, upcoming orders, and the required tools are received by the tool changer via Schröder's POS 3000 control software.

The fully automatic tool changer of the MAK 4 Evolution UD addresses the central challenges of your production processes:

- **Shorten equipping times**  
Minimize downtimes, shorten processing times, increase output and efficiency.
- **Avoid errors**  
The wrong tool is a frequent cause of errors in sheet metal forming. Errors can be avoided with automatic tool equipping. Quality increases, waste and costs are reduced.
- **Produce more flexibly and cost-effectively**  
The production lot sizes are decreasing – with automatic tool changing, even small lot sizes and single pieces are no longer to be feared as lost efficiency and a source of errors. Your company can make cheaper offers and generate additional orders.

# Gauge options

The MAK 4 Evolution UD is able to tackle the most diverse sheet metal formats without any difficulties.

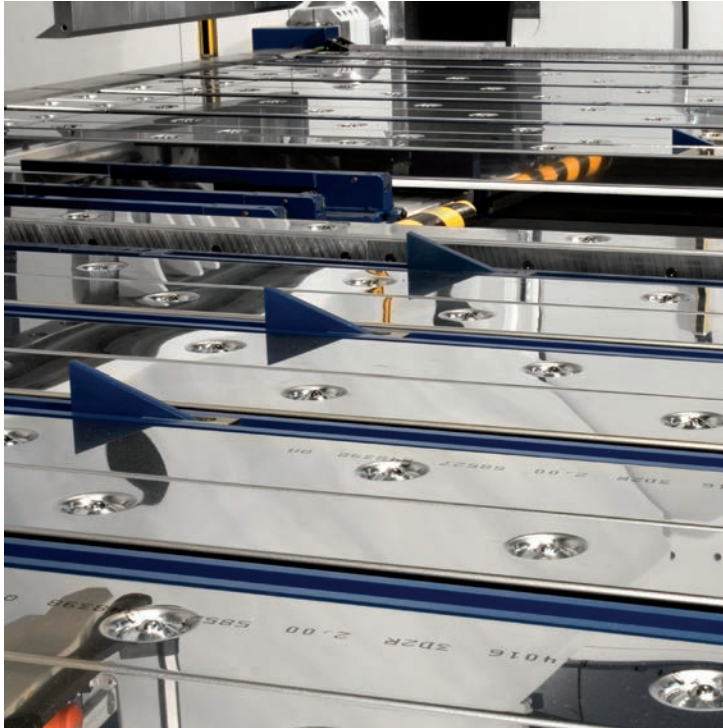

Example for a back gauge systems with pneumatic pop-up gauge fingers.



Suction plates in the back gauge table, controlled via POS 3000.

## Gauge system

Schröder offers a wide range of back gauge and integrated sheet support systems. The loading of the machine is ergonomic for the operator and gentle to the material. Ball transfers placed throughout the sheet support system provide a frictionless surface on which the workpiece is easy manipulated. Even in the basic version, the MAK 4 Evolution UD offers a support table of 1700 mm in U-shape. There are also 1500 mm angle stops on the left and right of the machine available.

In order to be able to bend long slim sheets exactly at a right angle, we recommend the pneumatic pop-up square arms assembled aisle side.

## Suction plates

In addition, suction plates are available as standard in the gauge table. These enable pneumatic fixing of the work piece: The suction gauge takes effect where the pop-up gauge fingers have no reliable grip if the work piece on the gauge side e.g. has cut-outs or roundings. One great advantage: The sheet gets pneumatically fixed and thanks to the intelligent software control all bends on one side can be carried out with one single manual action.

# Tools

For every folding task the right tools - with the high-quality tools from Schröder you are able to fold exactly and to bend radii with highest precision.

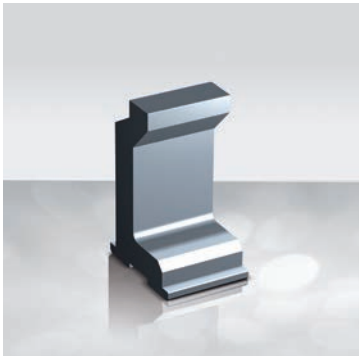

Segmented tools - on request also as individual solution

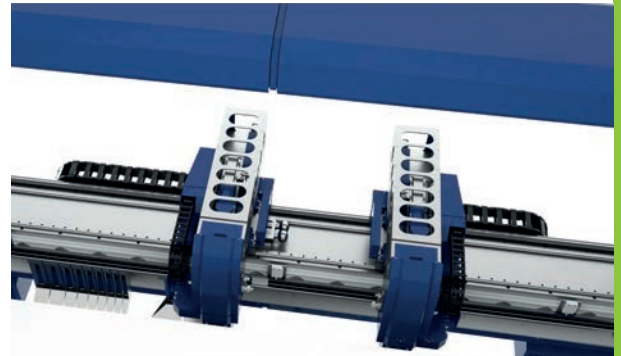
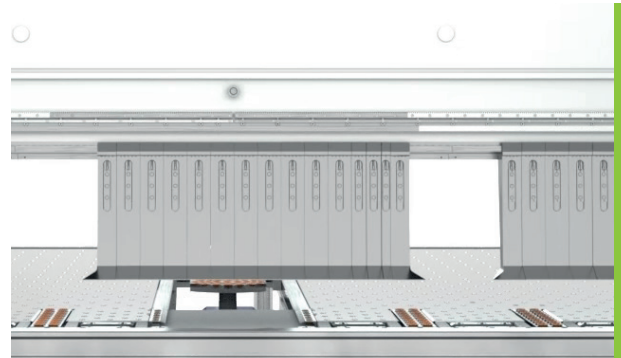

Picture above: Variable tools for all requirements

Picture below: Optional fully-automatic tool changer for clamping beam tools for max. tool height

As a flexible platform the MAK 4 Evolution UD is able to adapt to production-specific requirements using specific tools. When it comes to the bending process the right tool is essential - with the MAK 4 Evolution UD we can push all limits. For every product we can offer you the suitable tool for the clamping- and the folding beam. Should you require a particular geometry, just let us know. We will work out a customized solution for you.



Always tidy: Use our practical tool cart for blades, rails and segmented tools as optional equipment.

## Tool options

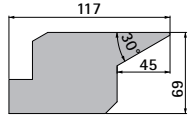
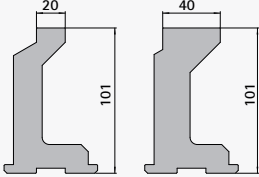
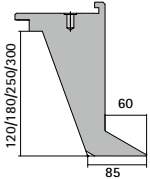
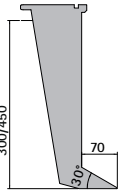
Tool options	
<p>Bottom beam tools WZS* 10400 oberflächengehärtet ca. 1100 N/mm<sup>2</sup> (nitriert)</p>	<p>Bottom beam blade one-piece, directly screwed - without finger grooves (min. gauge 130 mm) - with finger grooves</p> 
<p>Folding beam tools WZS 7000</p>	<p>Folding blade segmented (101/81 x 65 mm) surface-hardened (nitrated) ca. 1100 N/mm<sup>2</sup> No. 1 - L = 2 x (25/30/35/40/45/50) = 450 mm No. 2 - L = 200 mm (number according to work. length) Standard folding blade width: 10/15/20/25/30/35/40 or 50 mm</p> 
<p>Clamping beam tools WZS 5000</p>	<p>Goat's foot blade „C“, 30°, (from radius 1.0 mm), clearance 60 mm, clamping range 80 mm surface-hardened (nitrated), ca. 1100 N/mm<sup>2</sup></p> <p>No. 1 - L = 2 x (25/30/35/40/45/50) = 450 mm No. 2 - L = 200 mm (number according to work. length) from H = 300 mm, L = 100 mm Height 120/180/250 or 300 mm</p> 
<p>Clamping beam tools WZS 6000 for tool changer</p>	<p>Goat's foot blade „C“, 30°, (from radius 1.0 mm), clearance 70 mm, clamping range 104 mm surface-hardened (nitrated), ca. 1100 N/mm<sup>2</sup></p> <p>No. 1 - L = 2 x (30/35/40/45/50/55/60) = 630 mm No. 2 - L = 80 mm (number according to work. length) Height 330 or 400 mm</p> 
<p>Corner parts</p>	<ul style="list-style-type: none"> <li>- 1 pair fixed corner parts, L= 2x 110 mm = 220 mm (suitable for goat's foot set)</li> <li>- additional pair of hinged corner parts for tool heights from 250 mm</li> <li>- Clamping beam drive for active driven corner parts (free space of total clamping beam tooling is reduced by 31mm)</li> <li>- additional pair of active driven corner parts for tool heights from 250 mm (free space of total clamping beam tooling is reduced by 31 mm)</li> </ul>

\* WZS = Tool system

# Programming top performance

Visualize quality: POS 3000 3D-graphic control with simulation

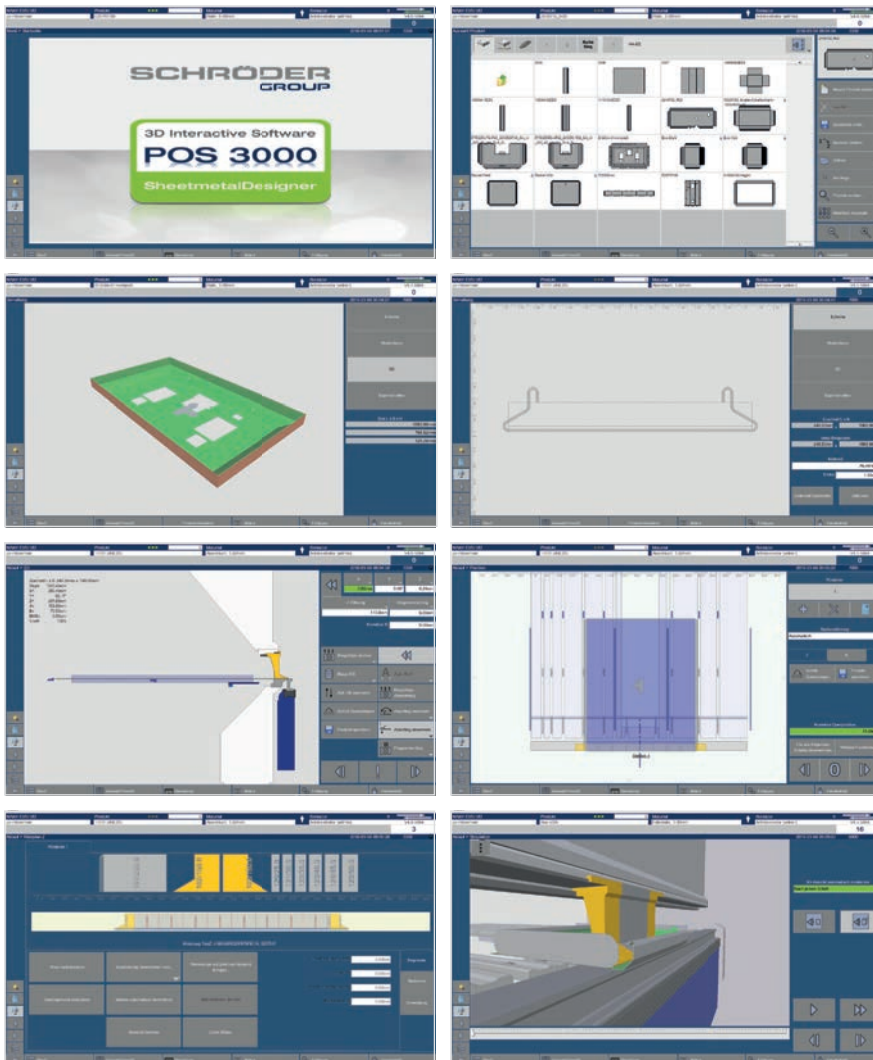

POS 3000 3D-graphic control: the result in front of your eyes - from the first steps up to simulation



Many things are possible: Up-and-Down-technique and huge opening heights create new possibilities.

## The POS 3000 3D-graphic control

Only the right software turns hardware into a flexible, easy to operate solution. With the POS 3000 3D graphic control, sheet metal working specialist Schröder has developed one of the most powerful controls on the market, and because both the hard and software come from a single provider, the MAK 4 Evolution UD and POS 3000 3D graphical control are a perfect match.

## From the drawing straight into production

The POS 3000 software control allows you to import DXF, BPX and GEO-files. Hence the most important product- and folding parameters can be imported automatically and without any intervention of the operator. Using this function, all shapes of a sheet can get displayed and the operator can choose between additional gauge options. This means substantial time savings and has the additional advantage that the operator does not have to program the workpiece that has to be bend. Optionally, 3D Stp files can also be processed and imported via the Schröder Unfold software.



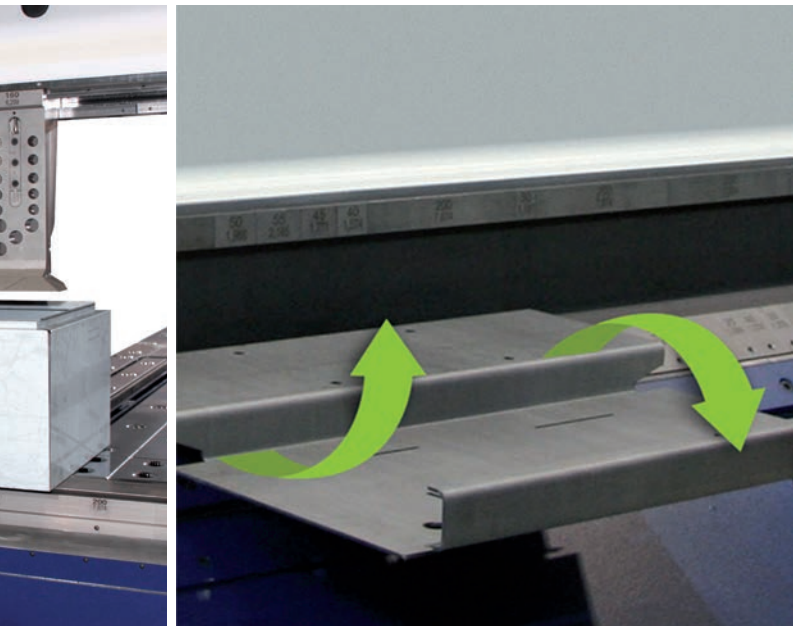

Up-and-Down-function:  
counter folds without turning upside down the sheet

Special feature: POS 3000 allows graphical programming. Machine, tools and workpiece – everything is displayed clearly. As we know: Operating staff and planning engineers are experienced in products and not for IT programming. That's why your employees simulate the bending process visually beforehand, check the result in the 3D bending simulator and ensure that the workpiece will be processed accurately from the first bend. Once a bending program has been generated it can be displayed quickly, checked visually, and adjusted according to material requirements.

Do you want to learn more about the POS 3000 3D graphical control? Please read our software brochure, or better yet: Allow us to show you live how the POS 3000 can help optimize your production.



## Highlights

- 3D-graphic control incl. schematic depiction of the machine, tools and work piece
- Intuitive, visual touchscreen-programming
- 3D-bending simulator for visual program inspection
- Automatic tool setup programming and control of tool changer
- Cycle time calculator
- PC-Version, CAM-connection, ERP/PPS-interfaces and DXF-converter available

### Option:

- Unfold software „SCHRÖDER Unfold“

# Dimensions and technical data

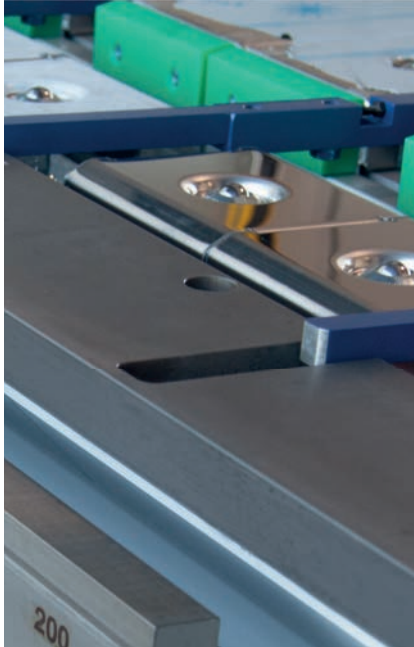

Bottom beam blade with finger grooves

MAK 4 EVOLUTION UD*	3 200 x 6.0	4 000 x 5.0	5 000 x 4.0
Working length (a)	3,240 mm	4,040 mm	5,040 mm
Sheet thickness (400 N/mm <sup>2</sup> )	6.0 mm	5.0 mm	4.0 mm
Machine length (b)	6,418 mm	7,218 mm	8,218 mm
Back gauge (c)			
U-3400	5,310 mm	-	-
U-4250	-	6,160 mm	-
U-5100	-	-	7,010 mm
Weight without back gauge	ca. 22,000 kg	ca. 23,500 kg	ca. 26,000 kg
Clamping beam			
Geometry	180°	180°	180°
Stroke	1090 mm		
Drive power	2 x 9.45 kW	2 x 9.45 kW	2 x 9.45 kW
Speed	100 mm/sec	100 mm/sec	100 mm/sec
Folding beam			
Adjustment, motorized	180 mm		
Drive power	2 x 9.4 kW	2 x 9.4 kW	2 x 9.4 kW
Speed	150°/sec	150°/sec	150°/sec
Folding center adjustment	100 mm		

\*On request the MAK 4 Evolution UD is also available in the following working length: 2 500 x 6.0 mm and 2 500 x 8.0 mm.

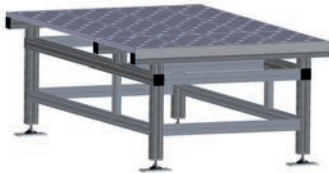

Dimension side table (wxd):  
 WL 3200: 1,336 x 1,864 mm  
 WL 4 000: 1,716 x 2,614 mm  
 WL 5 000: 2,216 x 3,433 mm

Alle dimensions in mm

Standard colour:

RAL 7035 light grey, RAL 5003 sapphire blue.

Special painting at an extra charge.

Alle dimensions in mm

Standard colour: RAL 7035 light grey, RAL 5003 sapphire blue. Special painting at an extra charge.

## Dimensions: MAK 4 Evolution UD without tool changer

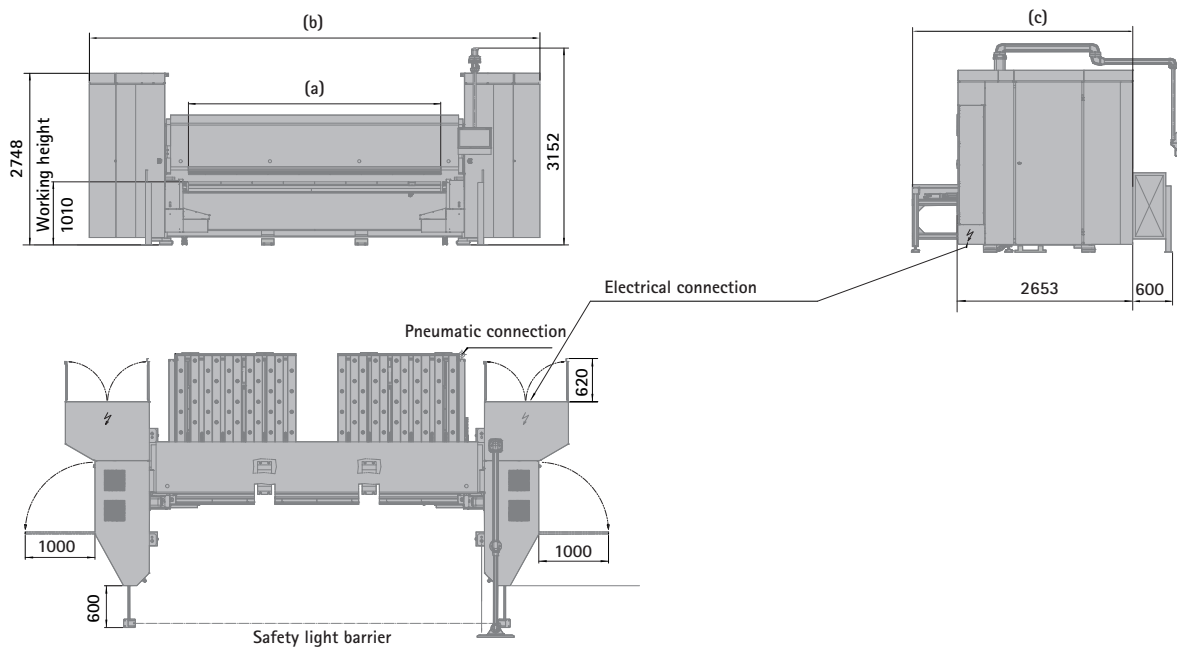

## Dimensions: MAK 4 Evolution UD with tool changer

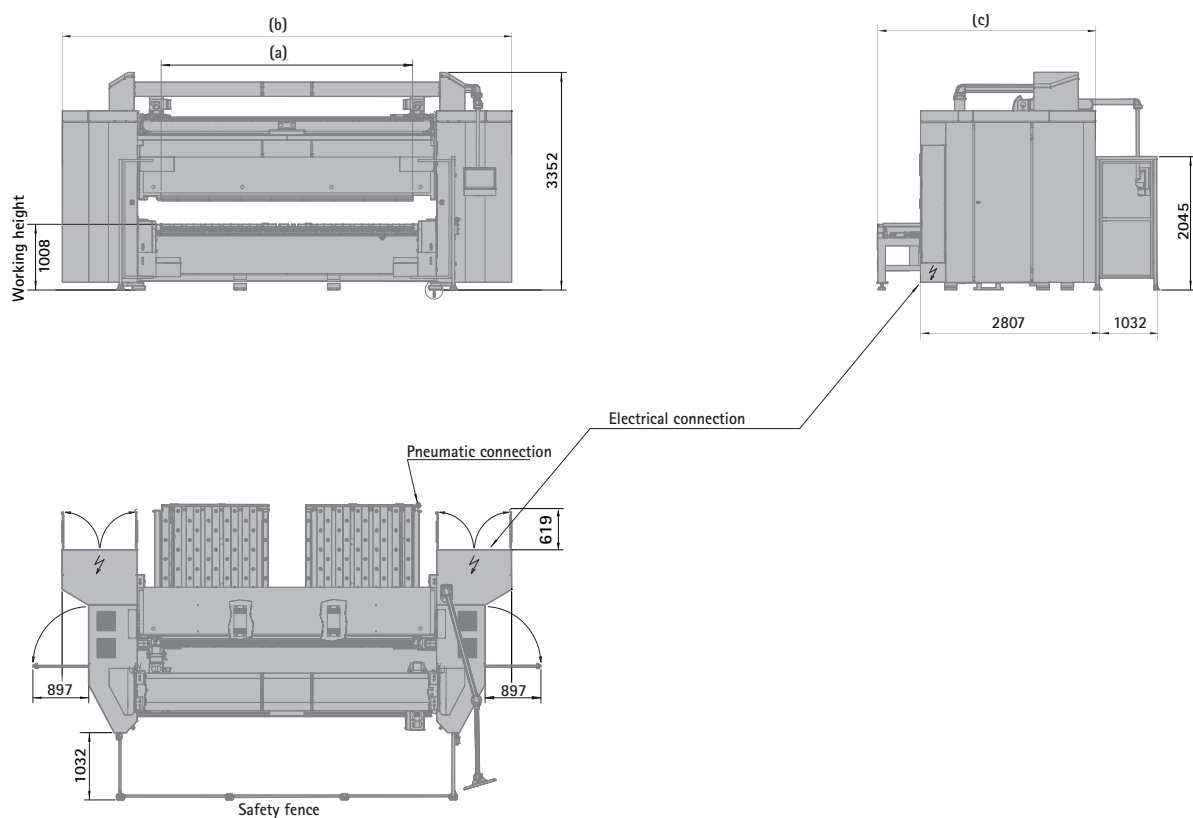



## Schröder Group

The Schröder Group consists of Hans Schröder Maschinenbau GmbH, which is located in Wessobrunn, Germany, SCHRÖDER-FASTI Technologie GmbH, located in Wermelskirchen, Germany and the SMU GmbH, located in Leinburg-Weißenbrunn.

Founded in 1949, Hans Schröder Maschinenbau GmbH unifies traditional and modern approaches in machine building: Successfully managed as a quality and customer-oriented, family-owned company, Hans Schröder Maschinenbau is specialized in the development of modern machine concepts for bending and cutting sheet metal.

The successful integration of the Fasti Company in 2006 and its worldwide presence make the Schröder Group one of today's leading providers of machines for bending, cutting, beading, flanging, and circular bending all types of sheet metal. The company's precision machines range from proven solutions for craftsmen to innovative, high-performance machines for automatic industrial production processes. 2021 the Schröder Group was expanded by the tool manufacturer SMU GmbH. Overall, the Schröder Group currently employs more than 300 people at various locations at home and abroad.

All information provided as a guide only  
and is subject to change at all times.  
HSM 230209EN

**Hans Schröder Maschinenbau GmbH**  
Feuchten 2 | 82405 Wessobrunn-Forst | Germany  
T +49 8809 9220-0 | F +49 8809 9220-700  
E [info@schroedergroup.eu](mailto:info@schroedergroup.eu)  
[www.schroedergroup.eu](http://www.schroedergroup.eu)

**SCHRÖDER**  
GROUP